



Asia-Pacific Economic Cooperation

2004/ASCC/036

Panel: 5

Linking Economic Partnerships?

Purpose: Paper Presented to ASCC, PECC Trade Forum – LAEBA
Conference

Submitted by: Andrew Elek, AUS PECC, Australia



APEC Study Centers Consortium Meeting
Viña del Mar, Chile
26 -29 May 2004



Linking economic partnerships?

ASCC-PECC meetings

Chile, May, 2002

Andrew Elek

*The Foundation for Development Cooperation
and
The Australian National University*

Stepping stones?

New closer economic partnerships are forming day by day

They are reducing some impediments between those involved:

liberalising some border barriers to trade and investment;

facilitating trade and investment by reducing other costs and risks.

Can these partnerships be linked to promote region-wide, or even global liberalisation and facilitation?

CEP = facilitation + PTA

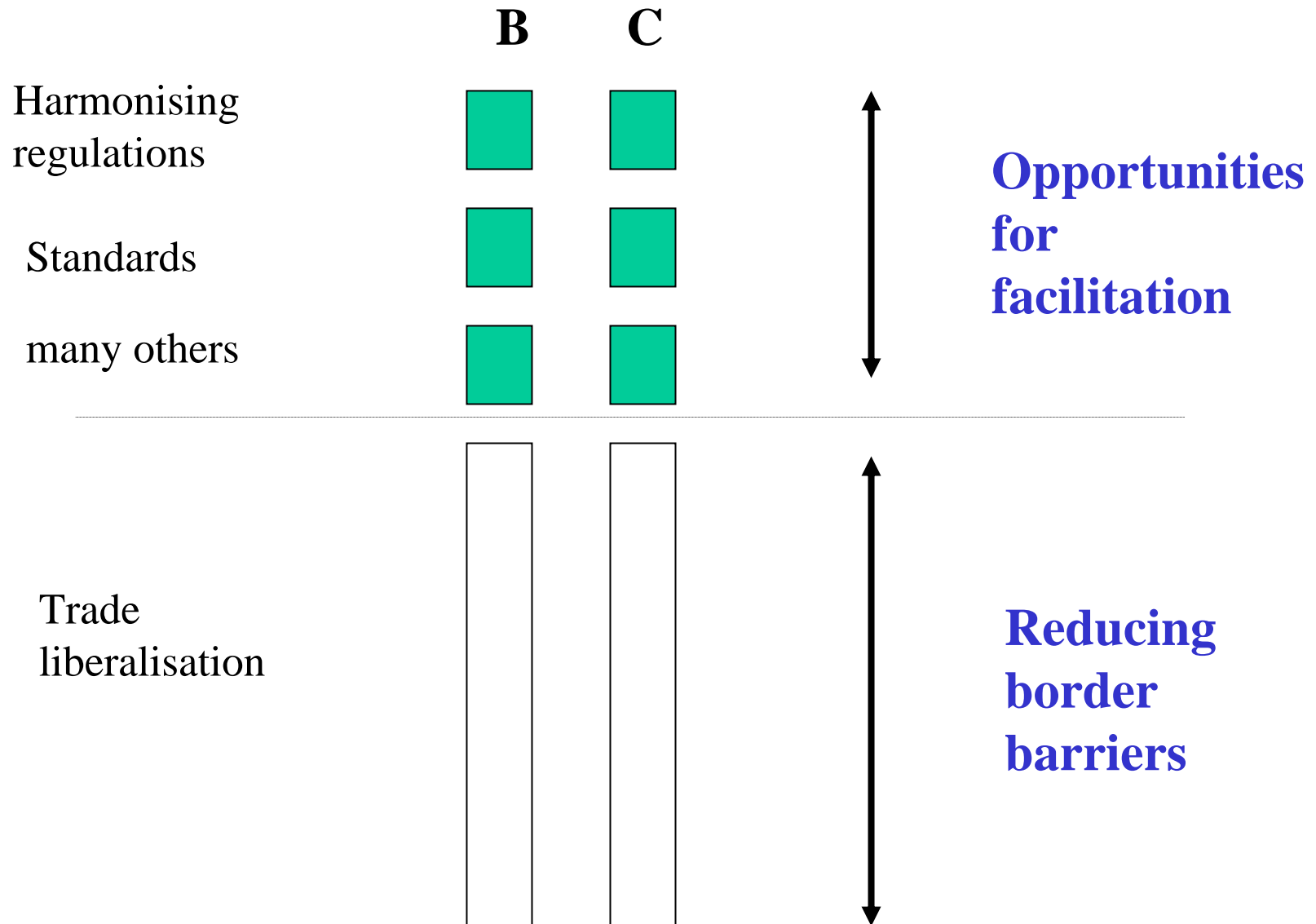

A comprehensive new partnership

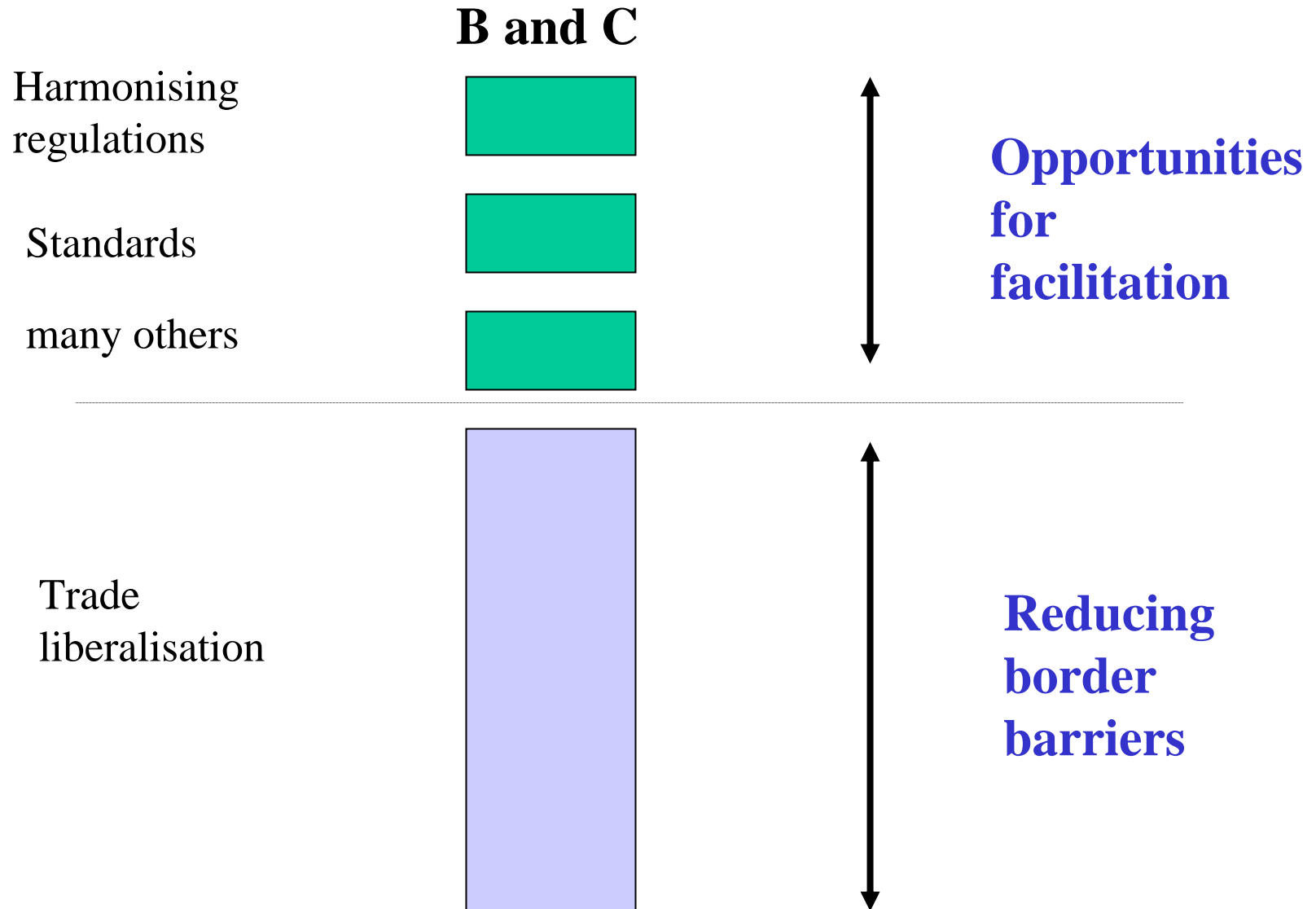

Towards global free trade and investment

More economies join ...

Harmonising
regulations



Standards



many others



**Opportunities
for
facilitation**



Trade
liberalisation

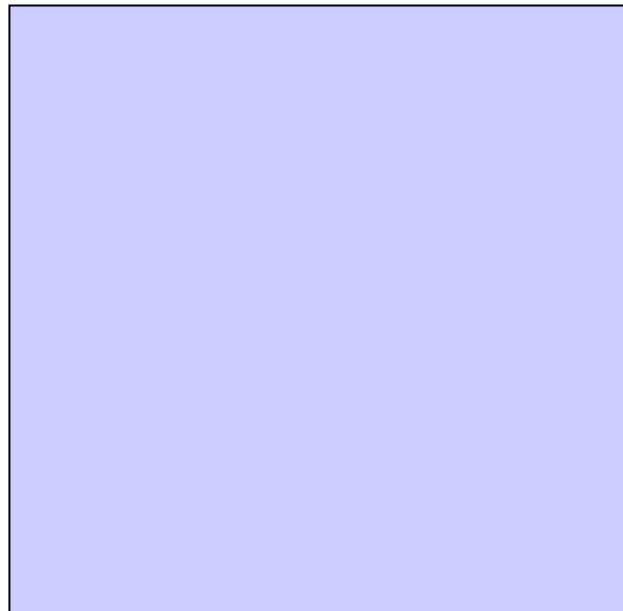

**Reducing
border
barriers**



Sensitive sectors

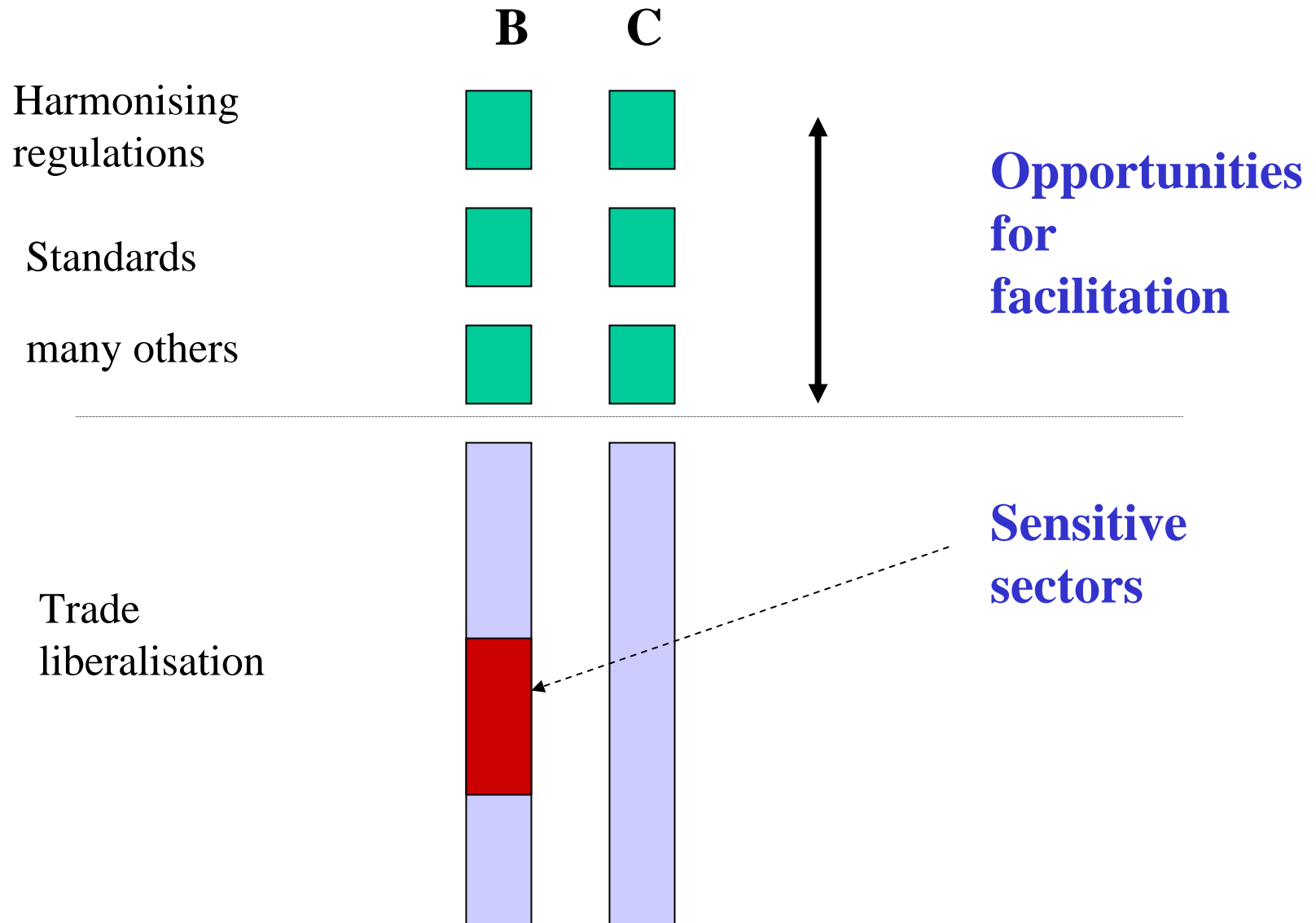

Threats to sensitive sectors

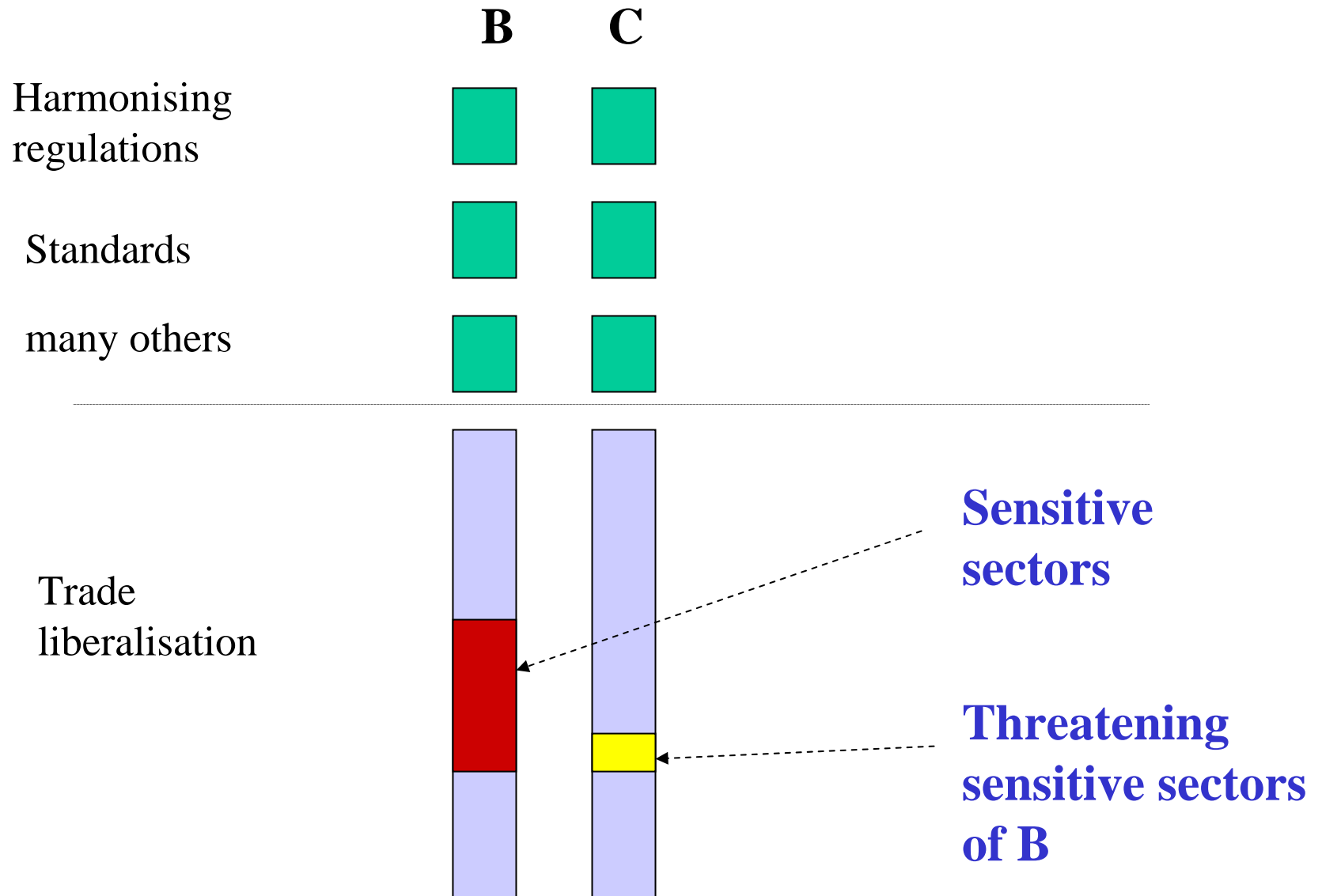

Other limits to cooperation

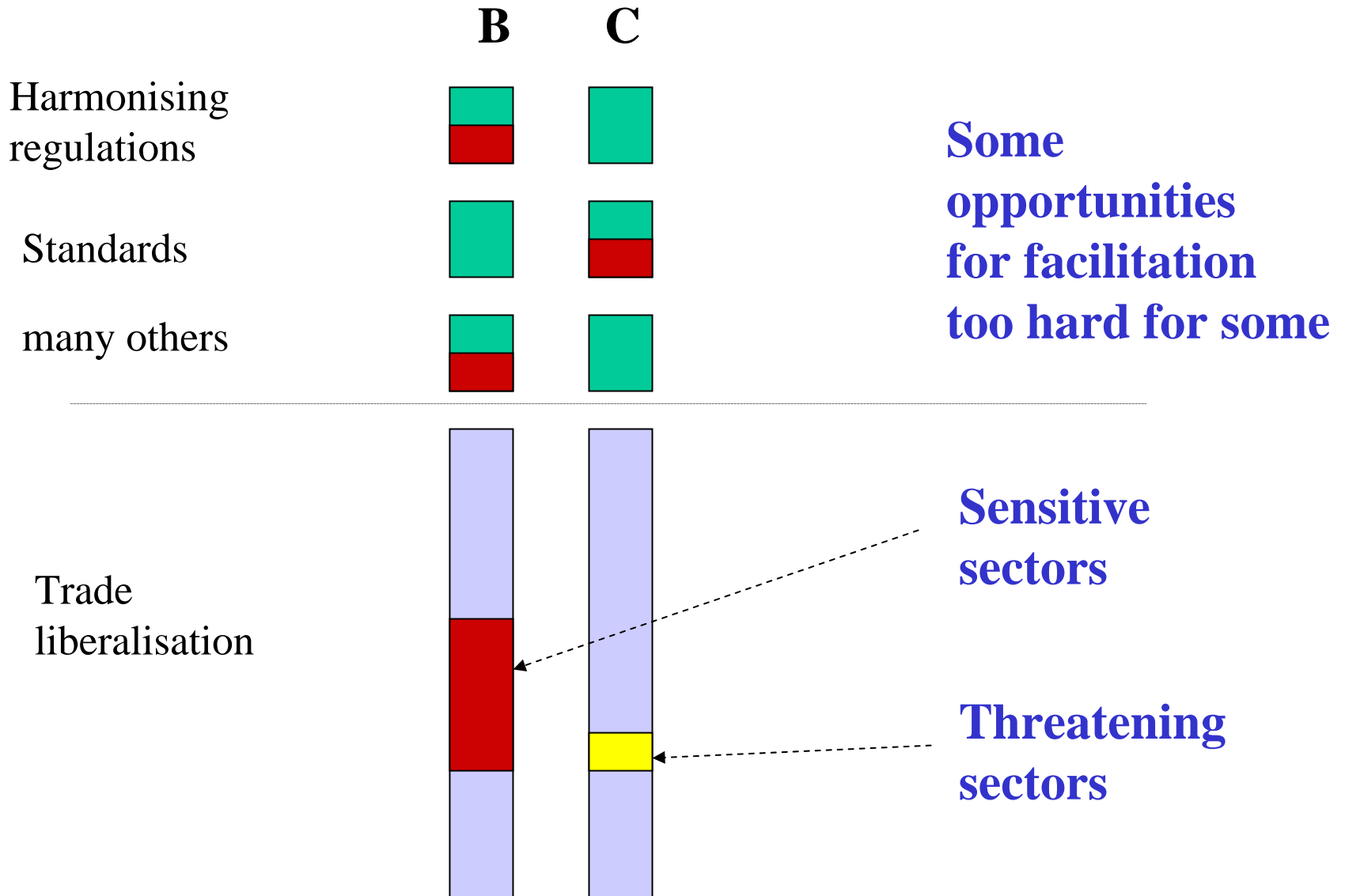

Possible CEP

B and C

Harmonising
regulations

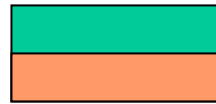

Opportunities seized

Standards

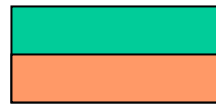

many others

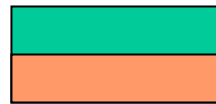

Other issues deferred

Free trade

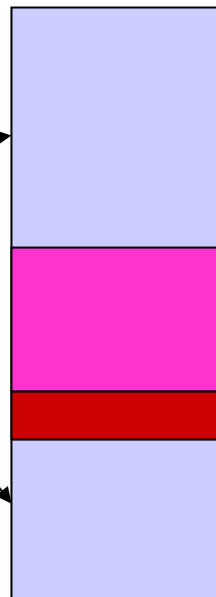

**Trade restricted by product
specific rules of origin**

Excluded from PTA

Towards new partnerships?

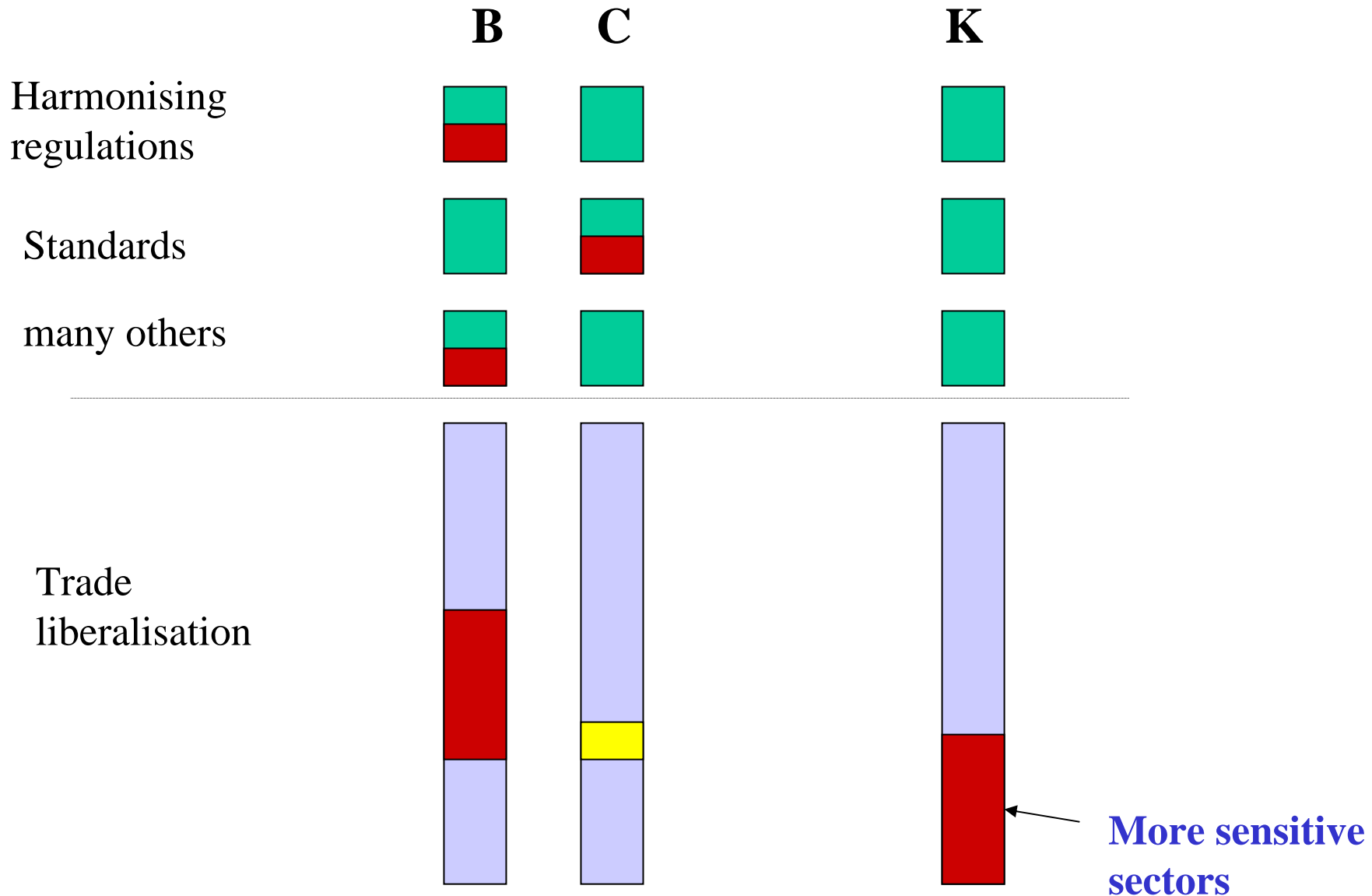

Towards new partnerships?

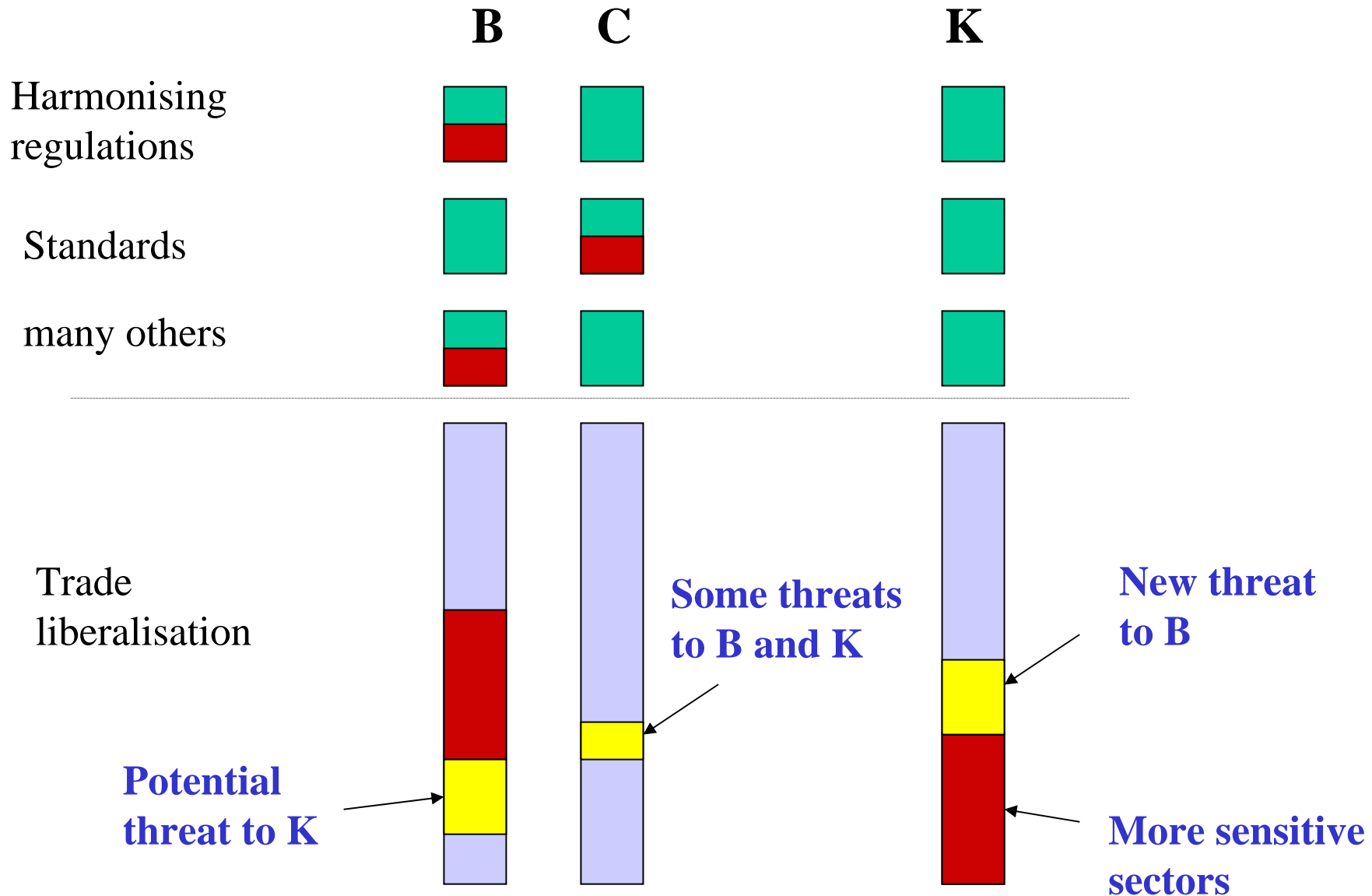

Linking C and K?

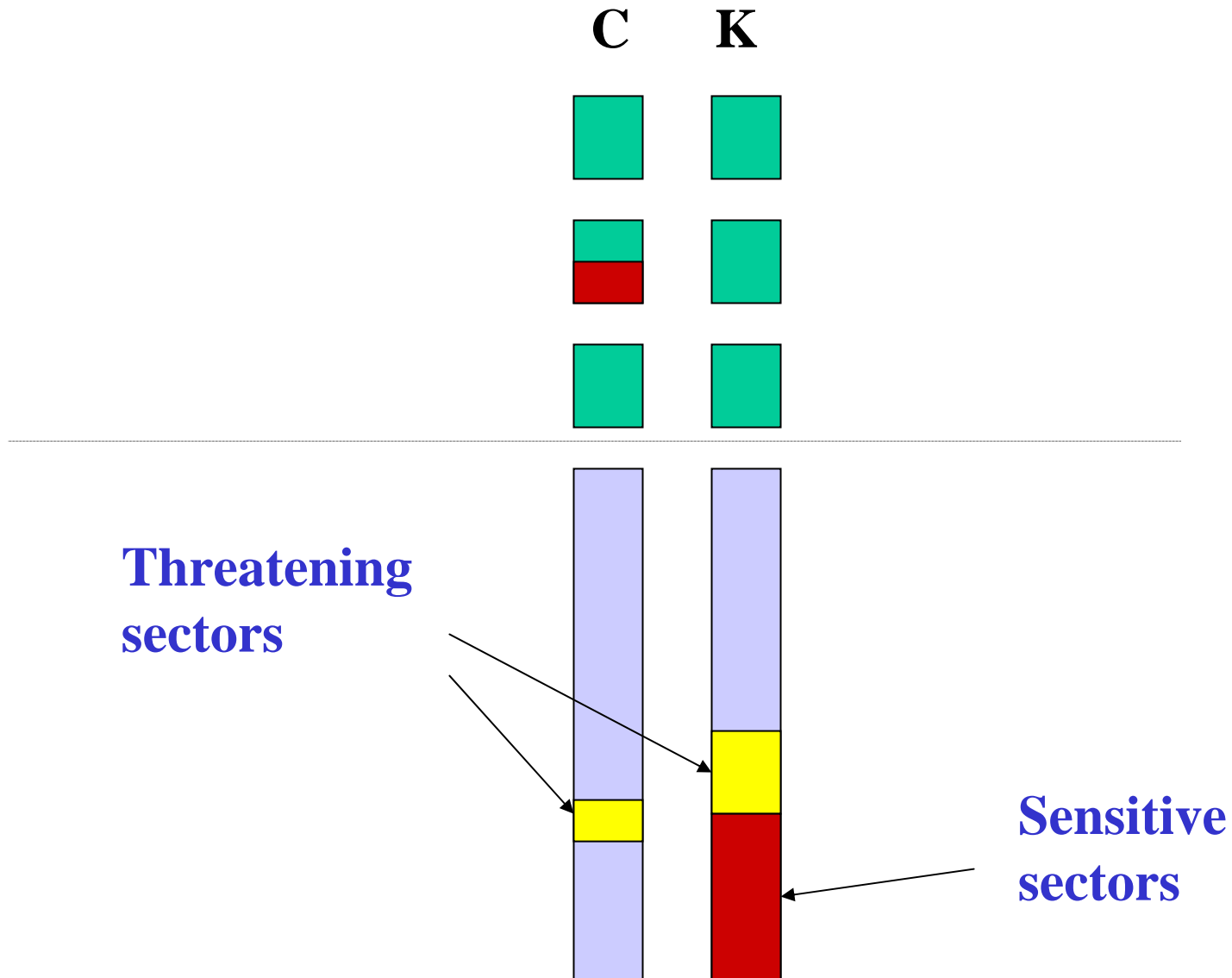

Possible CEP

C and K

Harmonising
regulations



Most opportunities seized

Standards

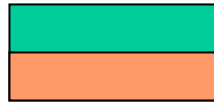

A few issues deferred

many others



Free trade

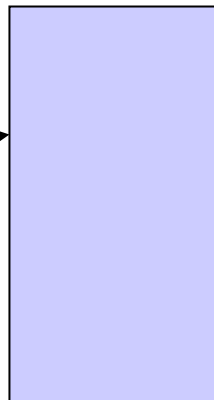

**Excluded
from PTA**



**Trade restricted by product
specific rules of origin
(imposed by K)**

Linking B and K?

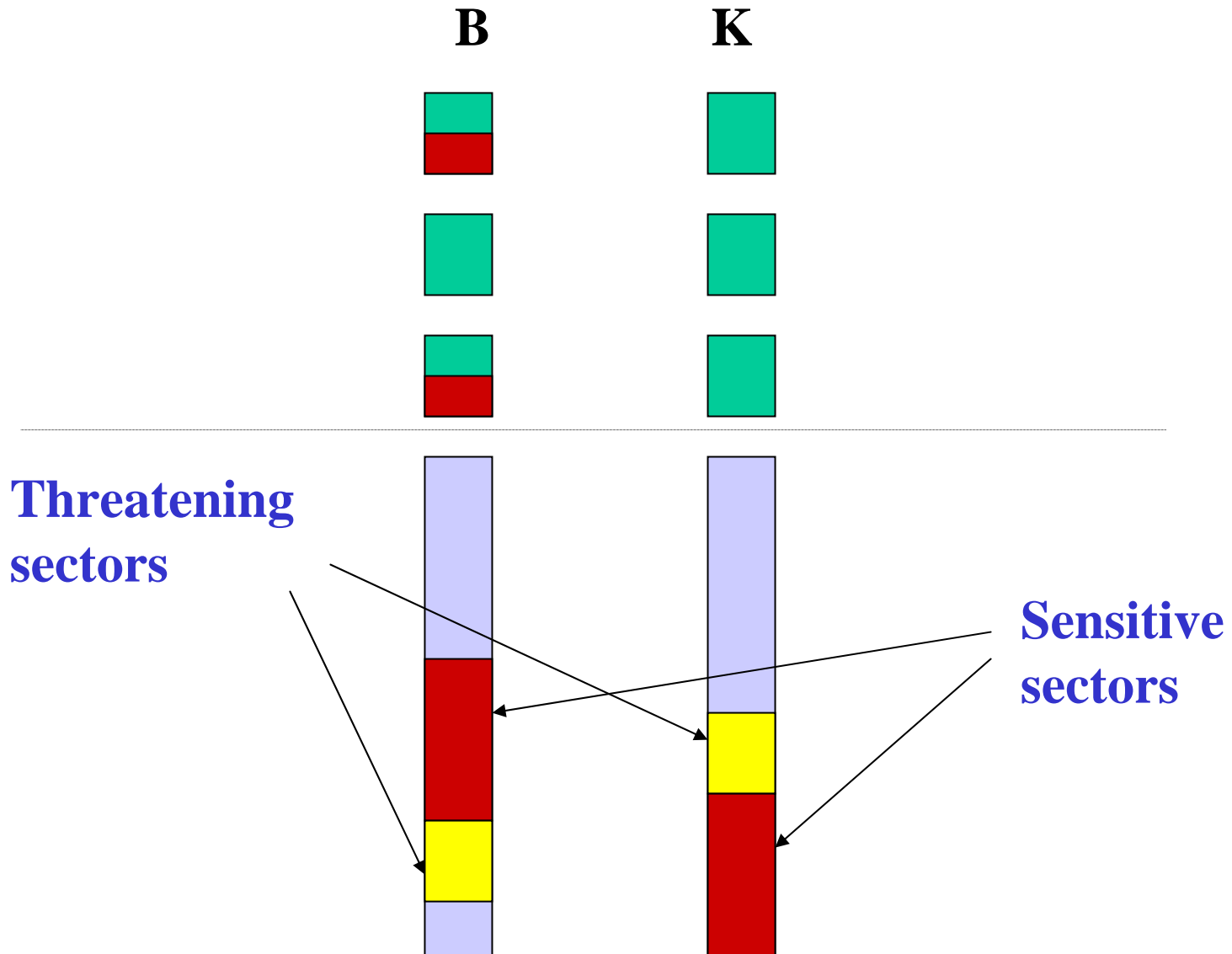

Too many exclusions

B and K

Harmonising
regulations

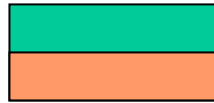

Standards



many others

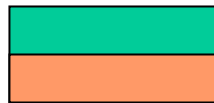

Some opportunities seized

some issues deferred

Free trade

**Excluded
from PTA**

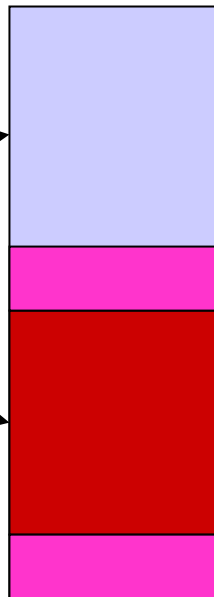

(imposed by B)

**Trade restricted by product
specific rules of origin**

(imposed by K)

Too many exclusions

B and K

Harmonising
regulations

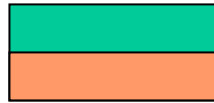

Standards



many others



**Can some opportunities
for facilitation be taken up?**

Free trade



**Excluded
from PTA**



(imposed by B)

**Trade restricted by product
specific rules of origin**

(imposed by K)

An APEC - wide PTA?



**Opportunities
for
facilitation**

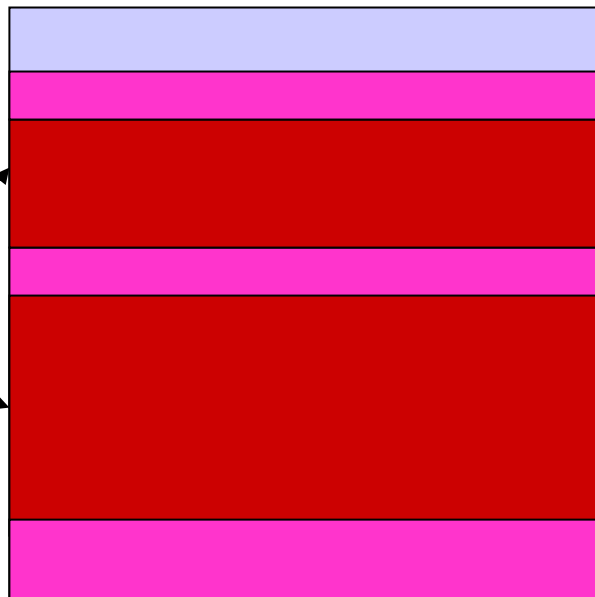

Free trade

**Trade restricted by product
specific rules of origin**

**Excluded
from
PTA**

Fewer sensitive sectors?

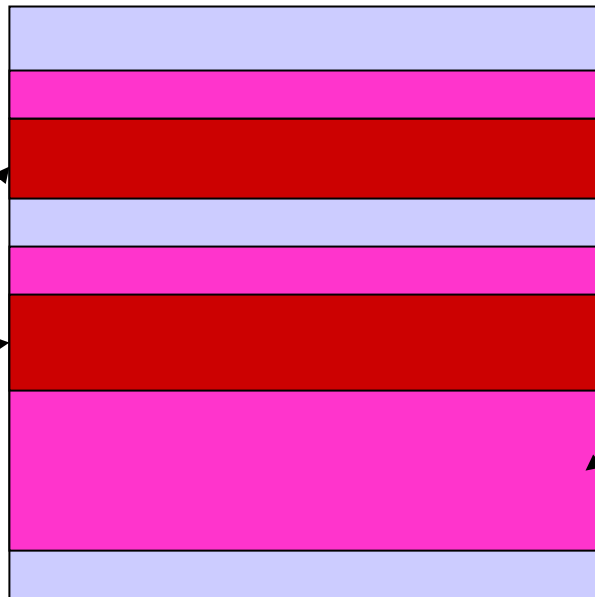
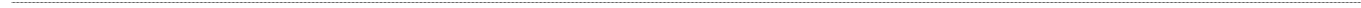

Free trade

Trade restricted by product specific rules of origin

Fewer sectors excluded from PTA



Multilateralise liberalisation?

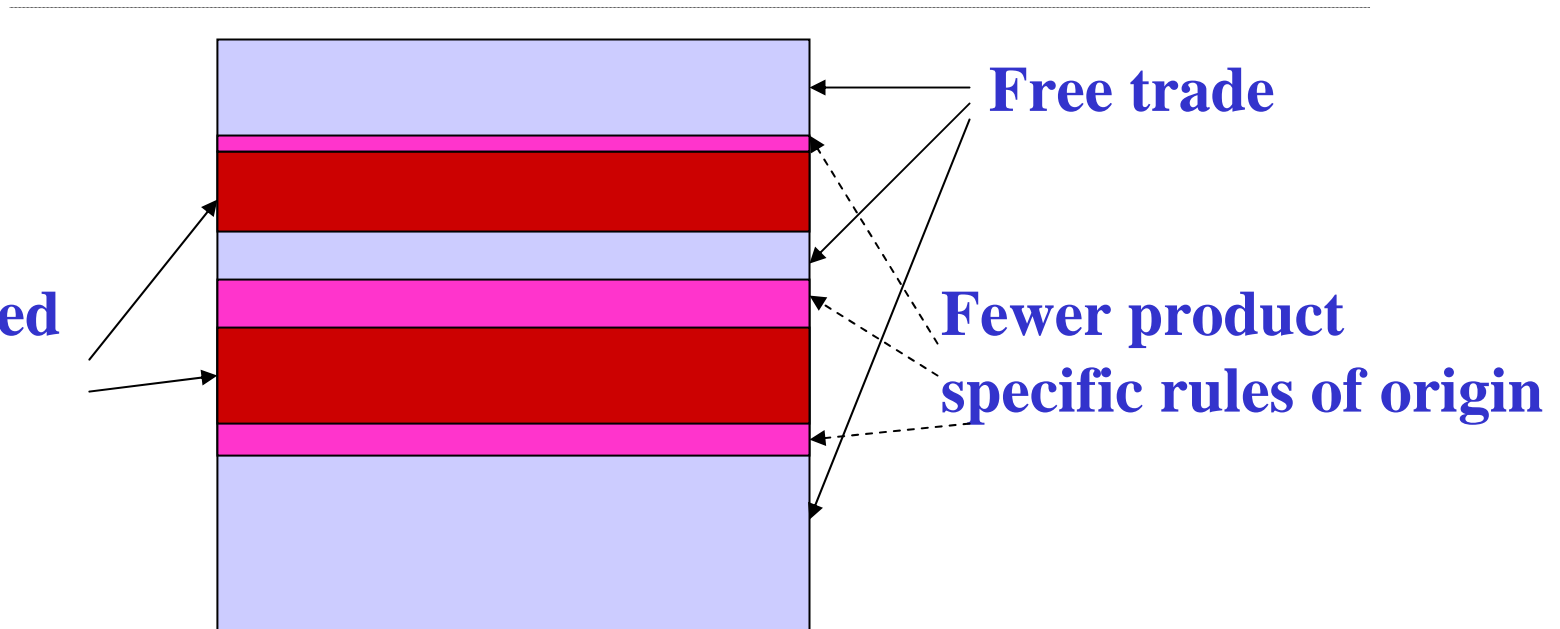

Promote APEC-wide facilitation



**Opportunities
for
facilitation?**

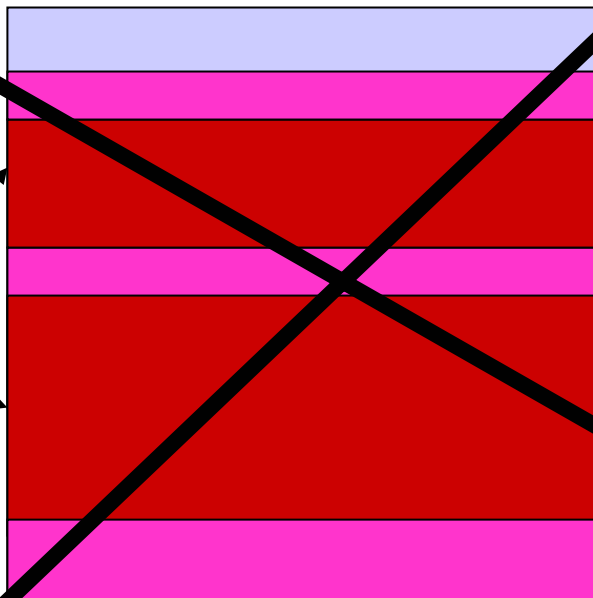

**Excluded
from
PTA**

**Region-wide
free trade
out of reach**

Promote APEC-wide facilitation



Seize more opportunities for facilitation

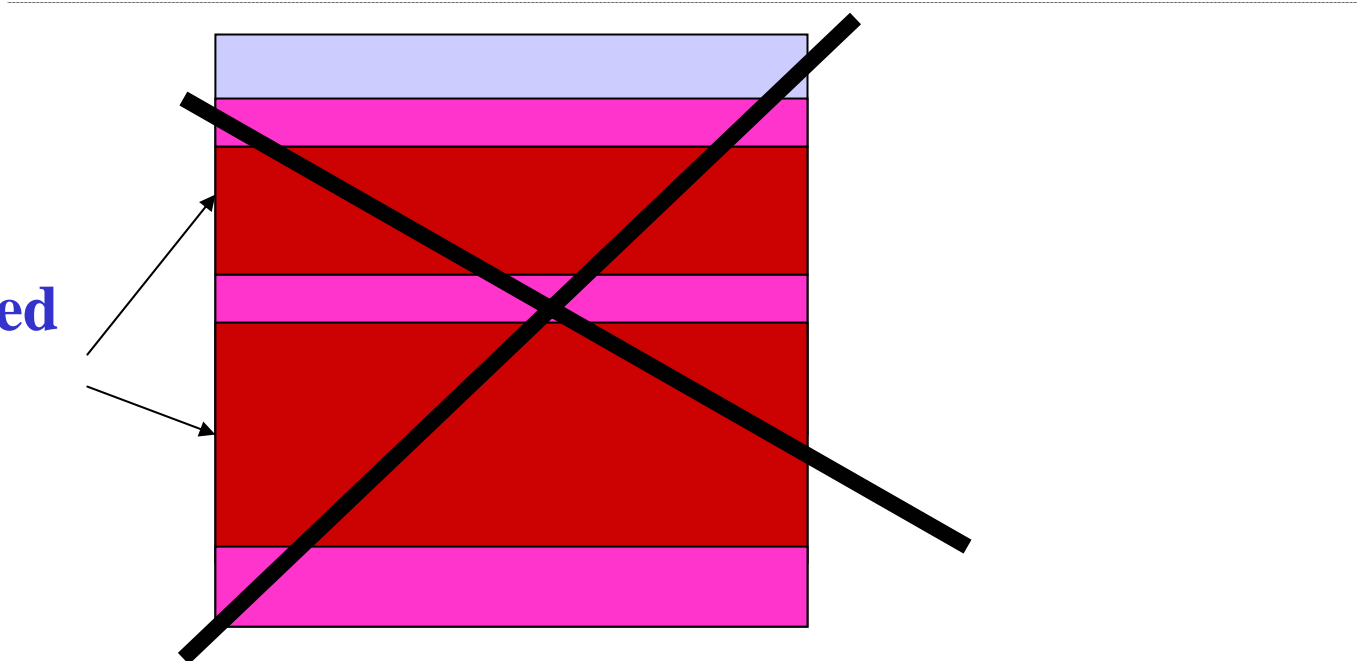

Excluded from PTA

RTAs among some , but not all APEC economies

B and C



**Links to other
economies**

??

C and K

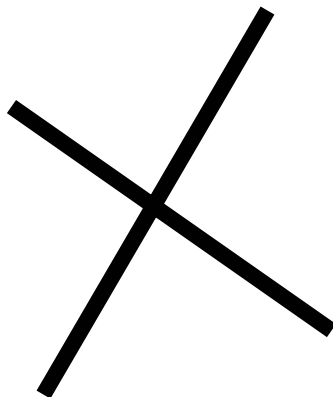
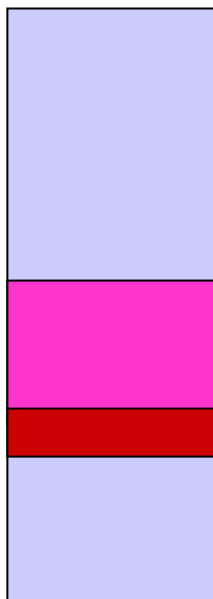

Can K be linked to B and C?

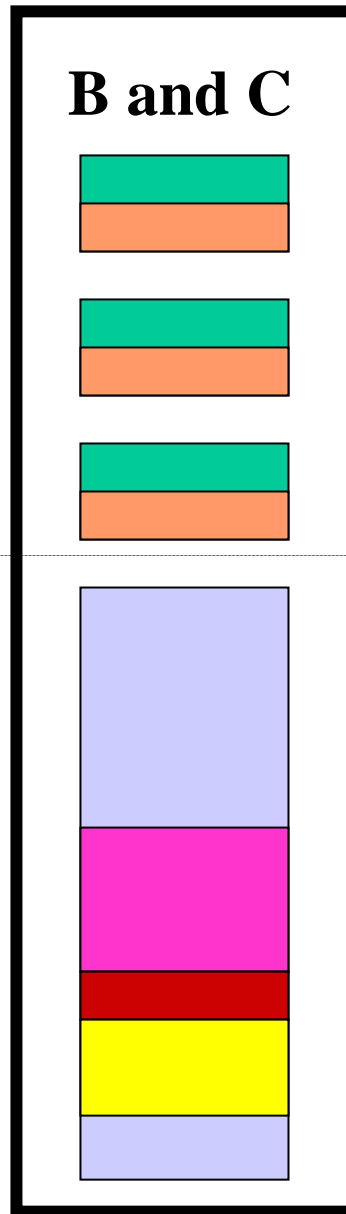

K

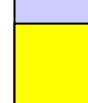

There are opportunities for wider facilitation

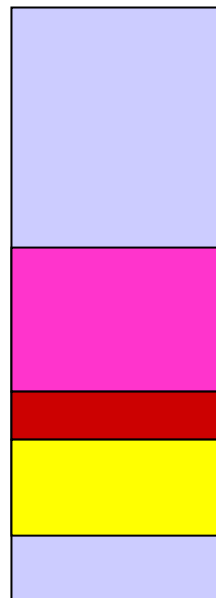
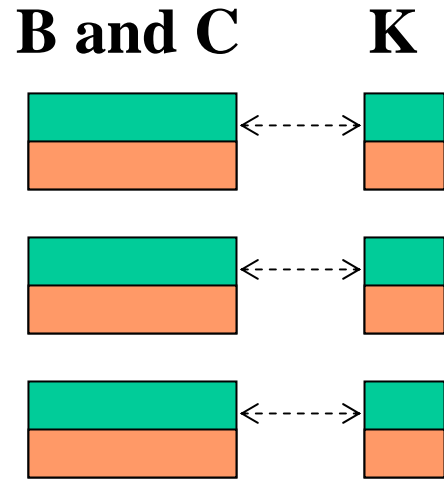

Don't lose opportunities for wider facilitation

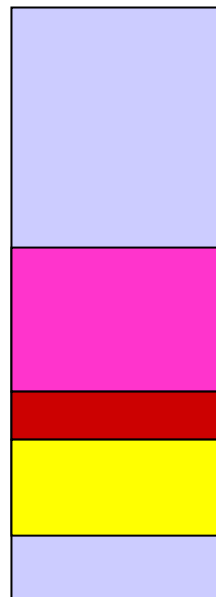
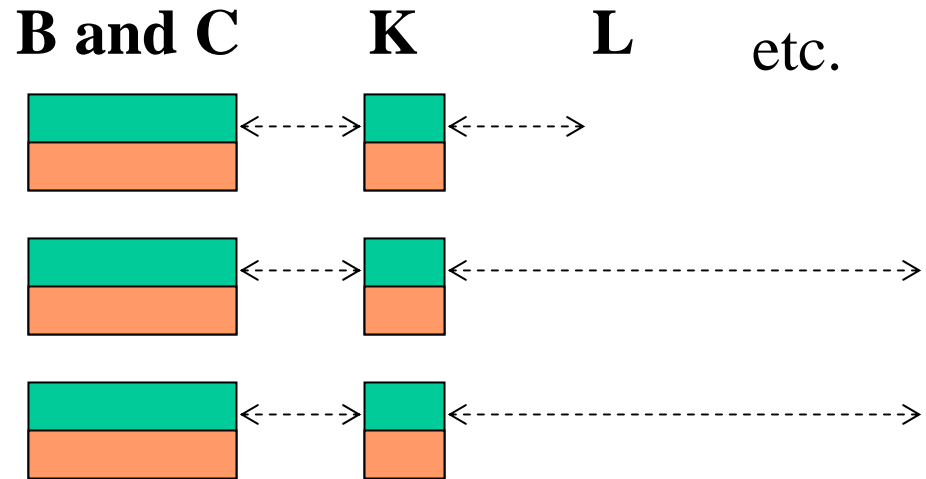

APEC-wide facilitation

economies

B C K etc.



**Opportunities
for
facilitation**

APEC-wide facilitation

economies

B C K etc.

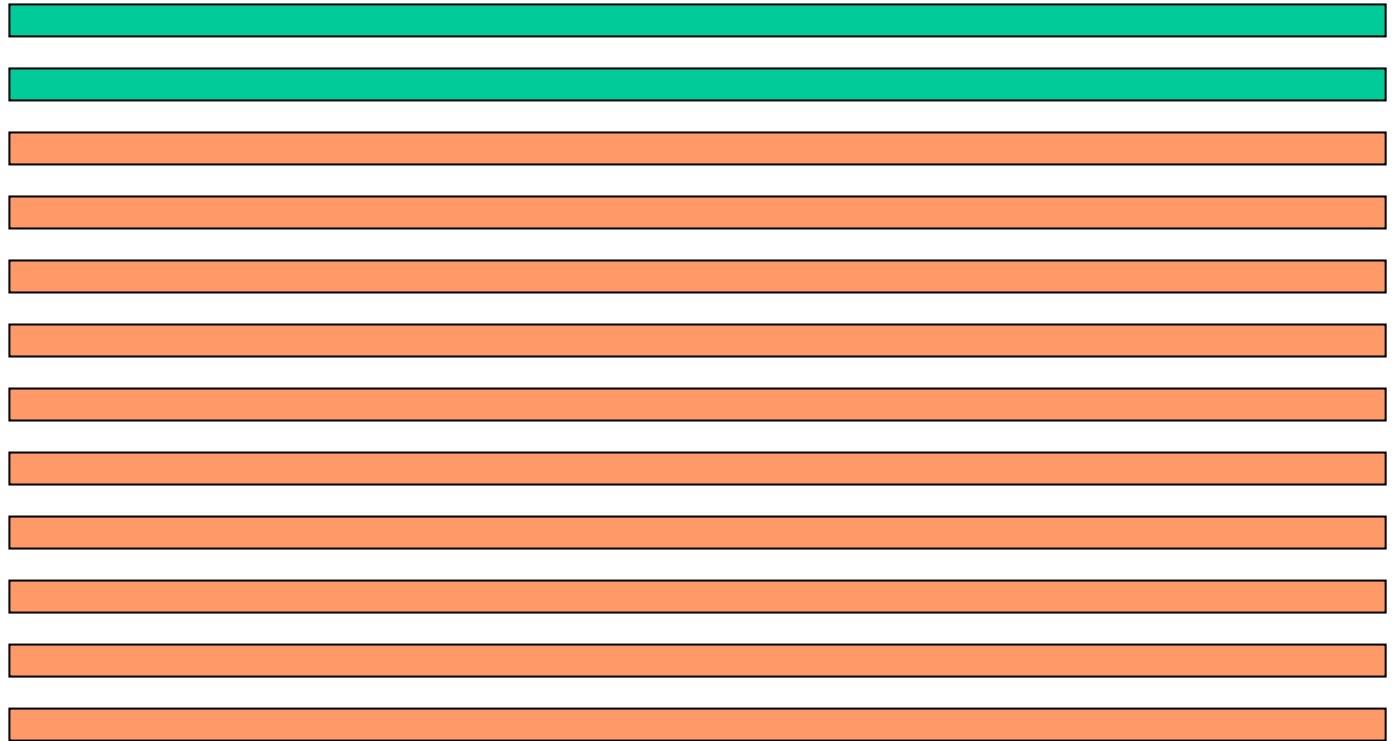

**Opportunities
for
facilitation**

Pathfinders

economies

B C K etc.

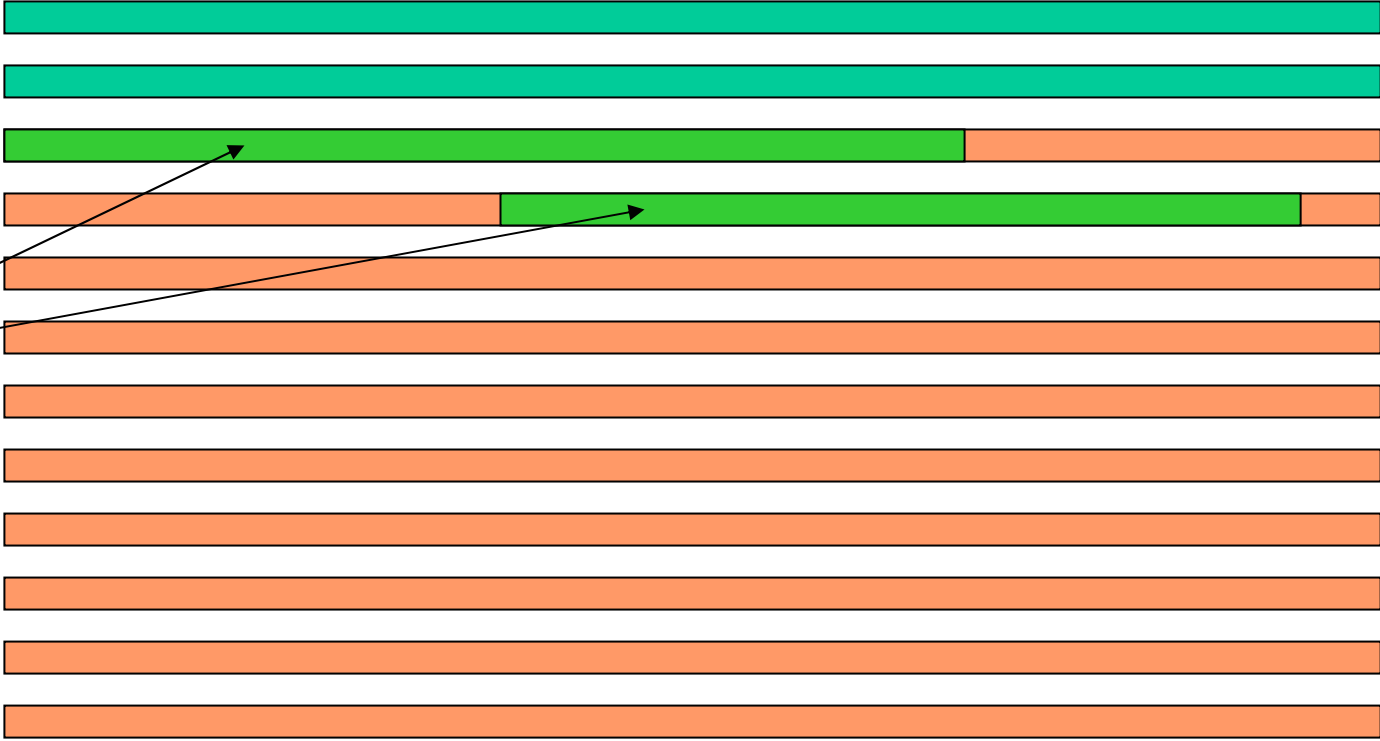

Pathfinder initiatives

APEC-wide facilitation

economies

B C K etc.

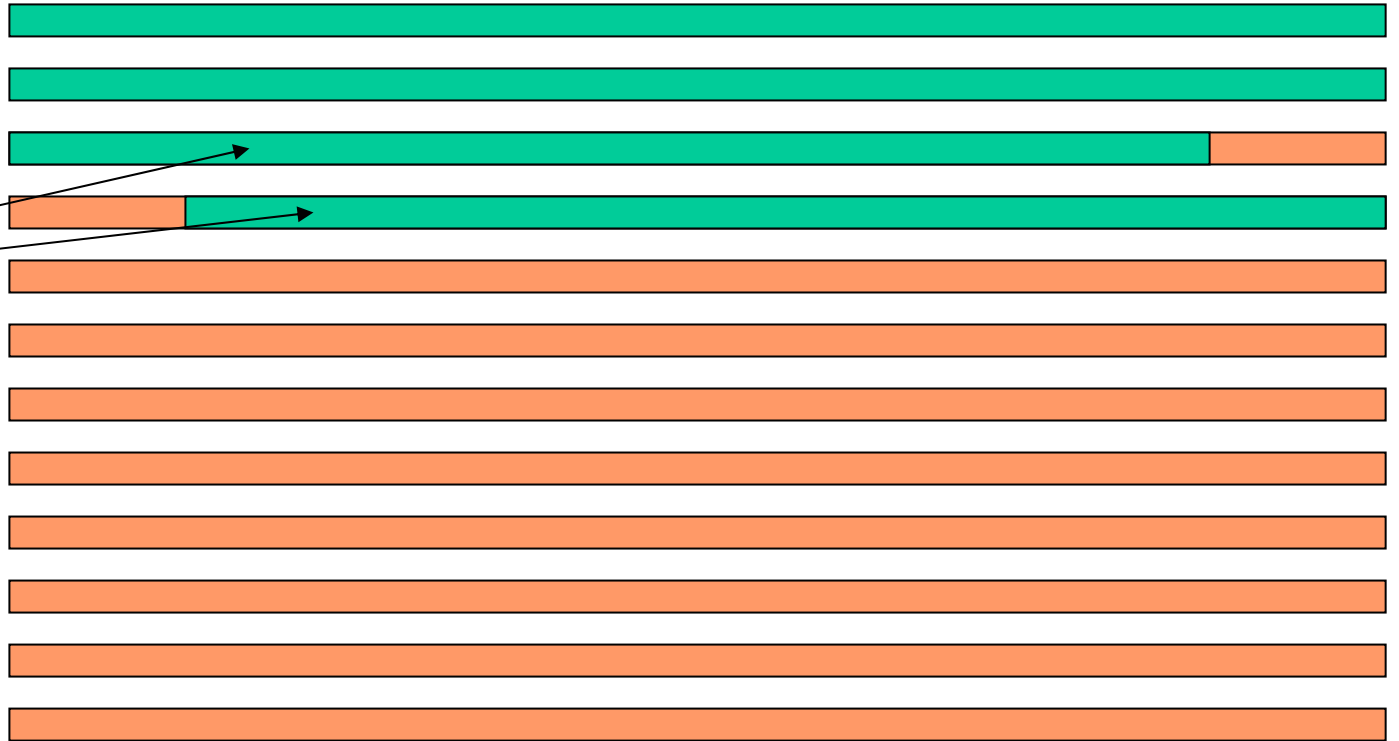

**These pathfinder
initiatives
can be
extended to
other APEC
economies**

Pathfinders and RTAs

At present, many new options to facilitate trade and investment are being implemented as part of CEPs (or RTAs)

Will these arrangements be open to accession by other economies?

can facilitation in RTAs be pathfinder initiatives within APEC?

Facilitation in new partnerships

economies

B C K etc.

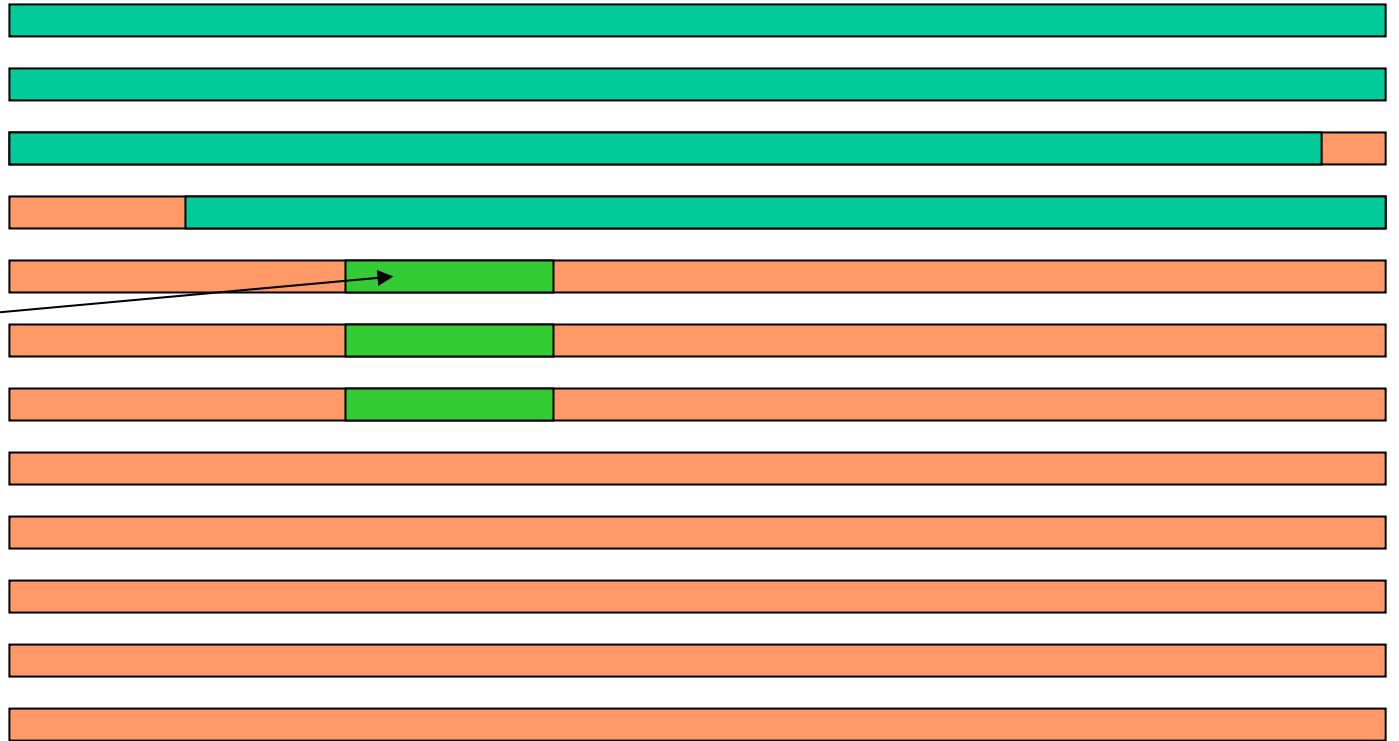

**Facilitation
in a CEP**

APEC-wide facilitation

economies

B C K etc.

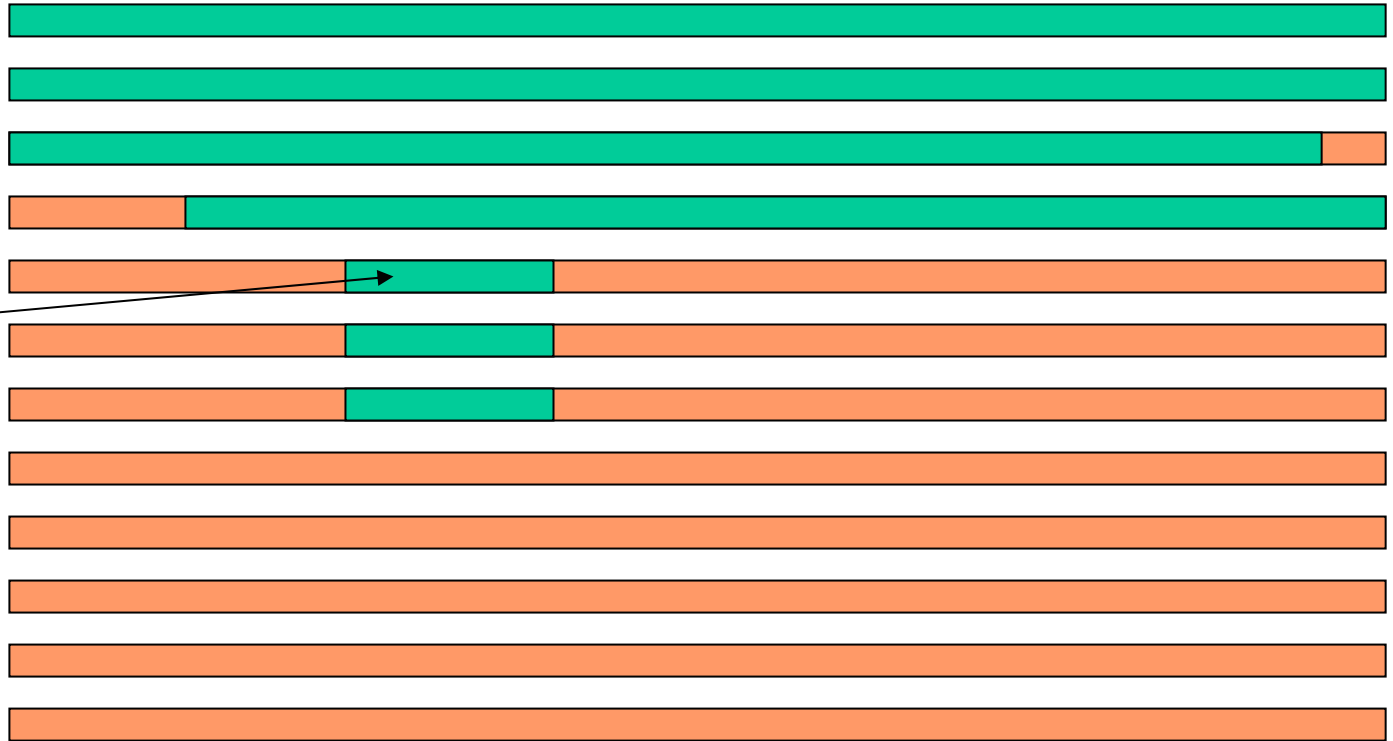

**Facilitation
in a CEP**
Can these be
pathfinders
for other APEC
economies?

APEC-wide facilitation

economies

B C K etc.

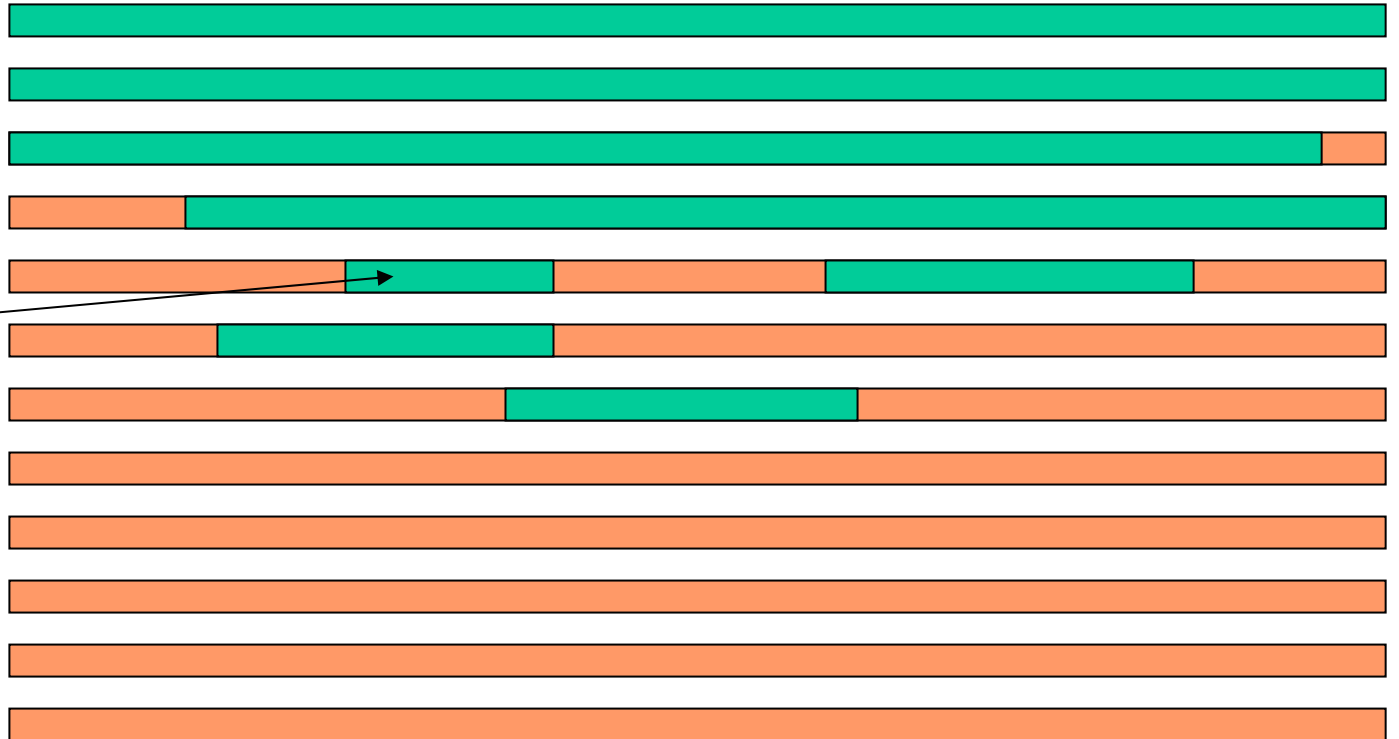

**Facilitation
in CEPs
Should be
pathfinders
for other APEC
economies**

APEC-wide facilitation

economies

B C K etc.

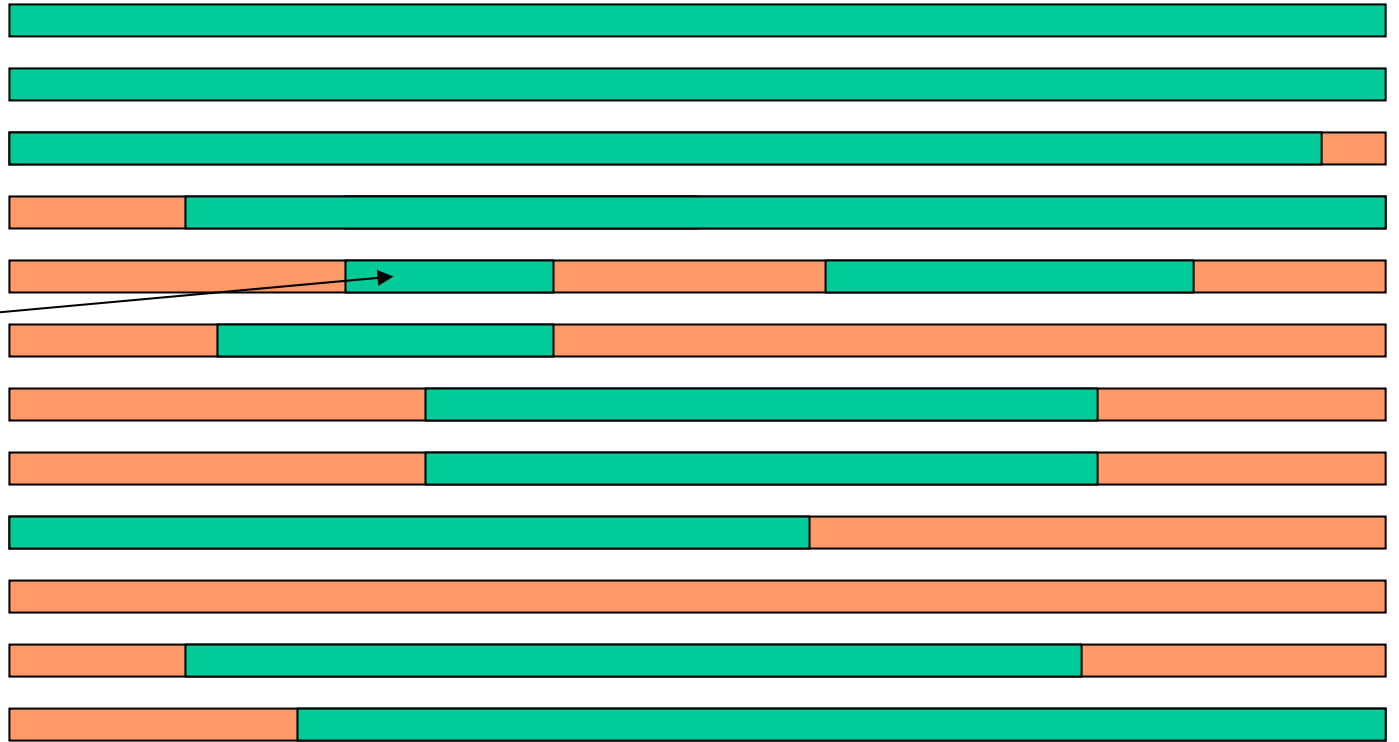

**Facilitation
in CEPs
Should be
pathfinders
for other APEC
economies**



Pathfinders in APEC

- Co-operative arrangements to facilitate trade and investment may be pioneered among pairs or groups of economies.

CEPs as pathfinders

- Co-operative arrangements to facilitate trade and investment may be pioneered among pairs or groups of economies.
 - Including in the context of closer economic partnerships (or regional trading arrangements) involving APEC economies.

Promoting pathfinders

- Co-operative arrangements to facilitate trade and investment may be pioneered among pairs or groups of economies.
 - Including in the context of closer economic partnerships (or regional trading arrangements) involving APEC economies.
- In line with the principles of the Osaka Action Agenda and the concept of pathfinder initiatives endorsed in the 2001 Shanghai Accord, they should be encouraged to do so.

Encouraging APEC-wide facilitation

- Co-operative arrangements to facilitate trade and investment may be pioneered among pairs or groups of economies.
 - Including in the context of closer economic partnerships (or regional trading arrangements) involving APEC economies.
- In line with the principles of the Osaka Action Agenda and the concept of pathfinder initiatives endorsed in the 2001 Shanghai Accord, they should be encouraged to do so.
- In the interest of promoting wider free and open trade and investment, any economy whose government adopts policies compatible with any existing or proposed co-operative arrangement should be able to, and be encouraged to, become party to any of these arrangements.